

Plan / Top View

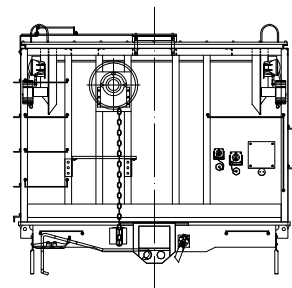

End View West
(leftside)

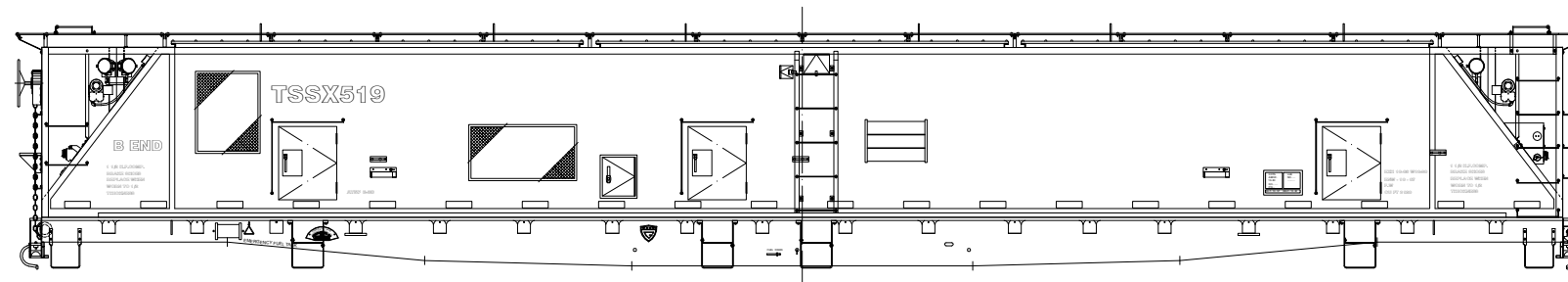

South Elevation View

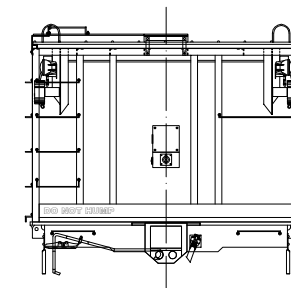

End View East
(rightside)

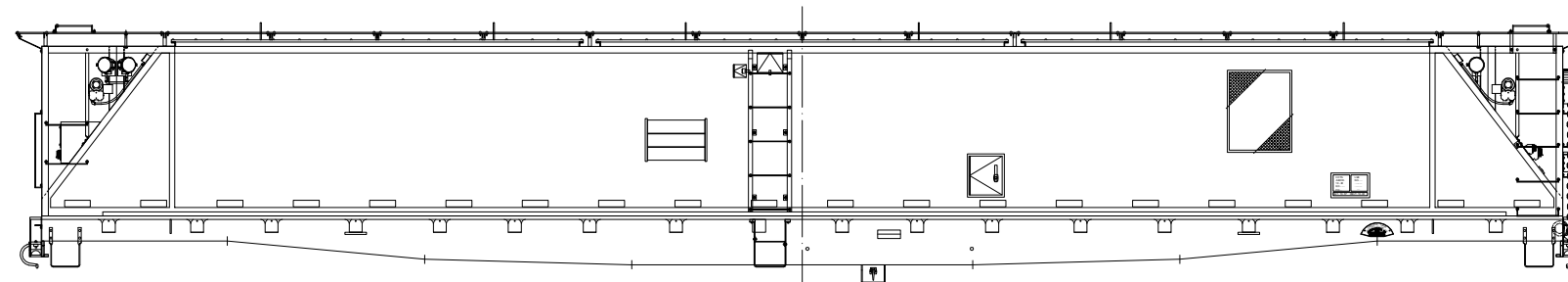

North Elevation View

Common Snap
POINT



104

Total Units Combined for discussion / verification / modeling options
White Train Buffer Car Unit / Plans & Elev Views
for: **Amarillo Railroad Museum HO Layout**

SCALE: 0.5517 = 48 units
1/87 HO Scale 3.5mm = 1 ft

D
Print Date:
10-25-2019

b carter designs
Commercial Interiors
Space Planning / Design
P O Box 33781 Amarillo, TX 79120
Mob 806-690-3410 Hm 806-352-8459
bcarterdesigns@att.net

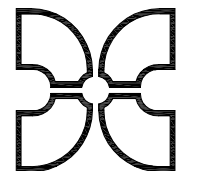

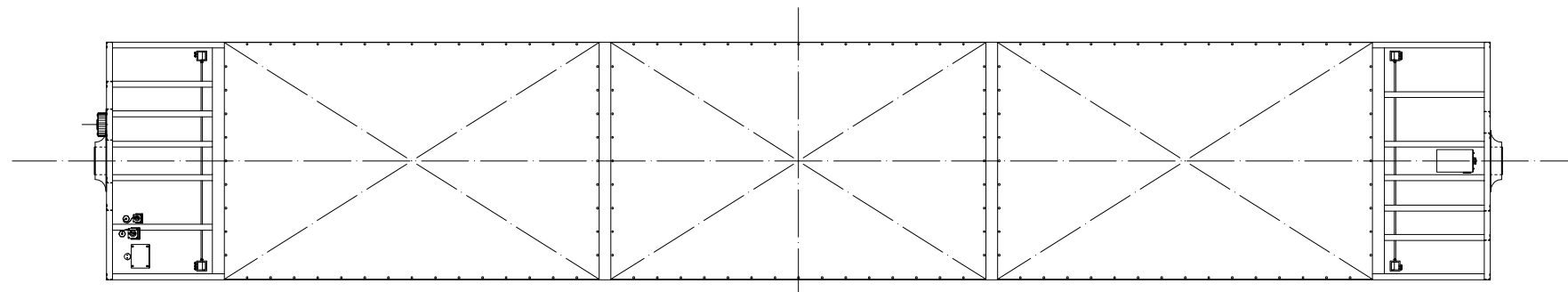

Plan / Top View

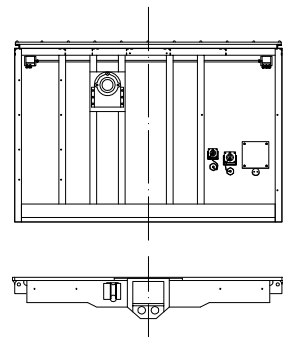

End View West
(leftside)

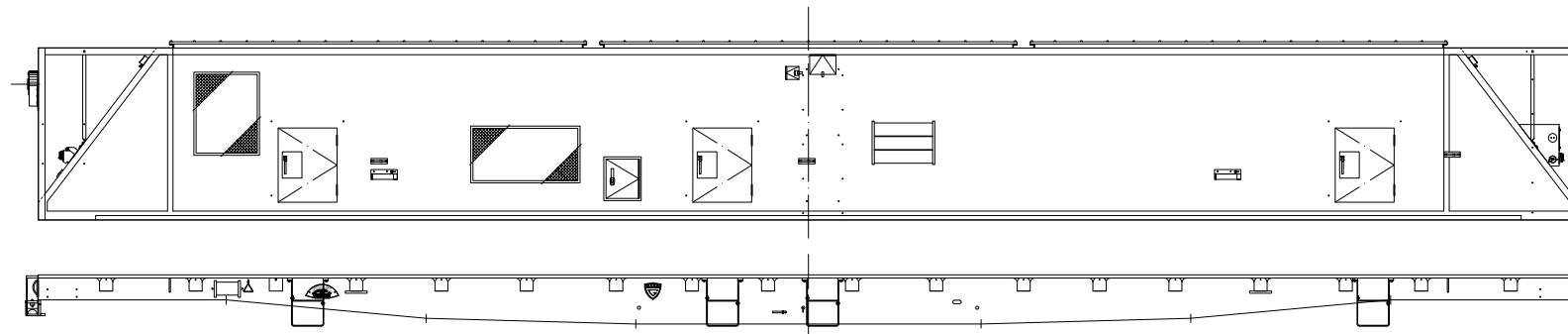

South Elevation View

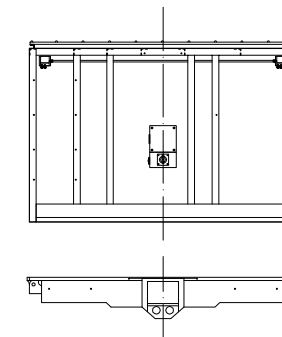

End View East
(rightside)

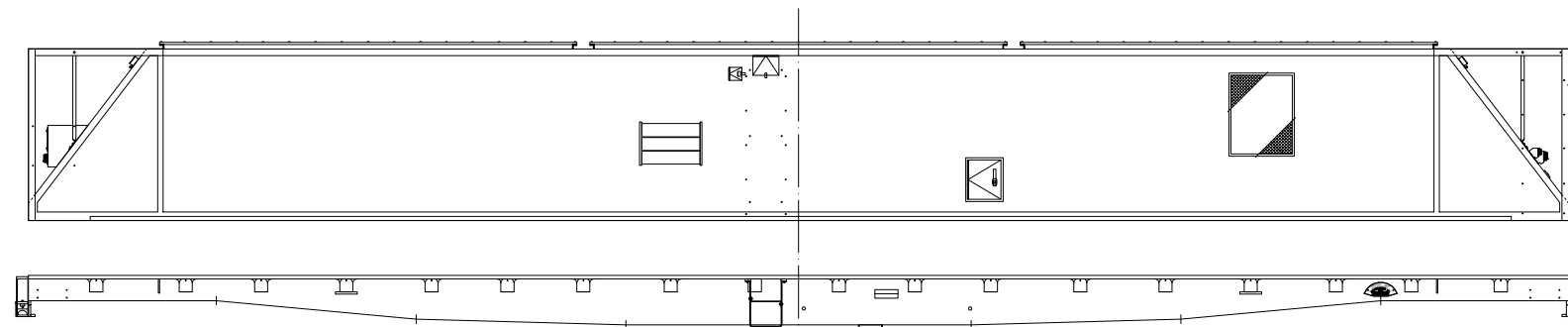

North Elevation View

Common Snap
POINT



105

Main Unit Parts for discussion / verification / modeling options
White Train Buffer Car Unit / Plans & Elev Views
for: **Amarillo Railroad Museum HO Layout**

SCALE: 0.5517 = 48 units
1/87 HO Scale 3.5mm = 1 ft

E
Print Date:
10-25-2019

b carter designs
Commercial Interiors
Space Planning / Design
P O Box 33781 Amarillo, TX 79120
Mob 806-690-3410 Hm 806-352-8459
bcarterdesigns@att.net

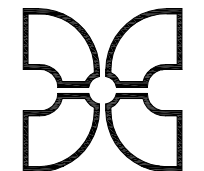

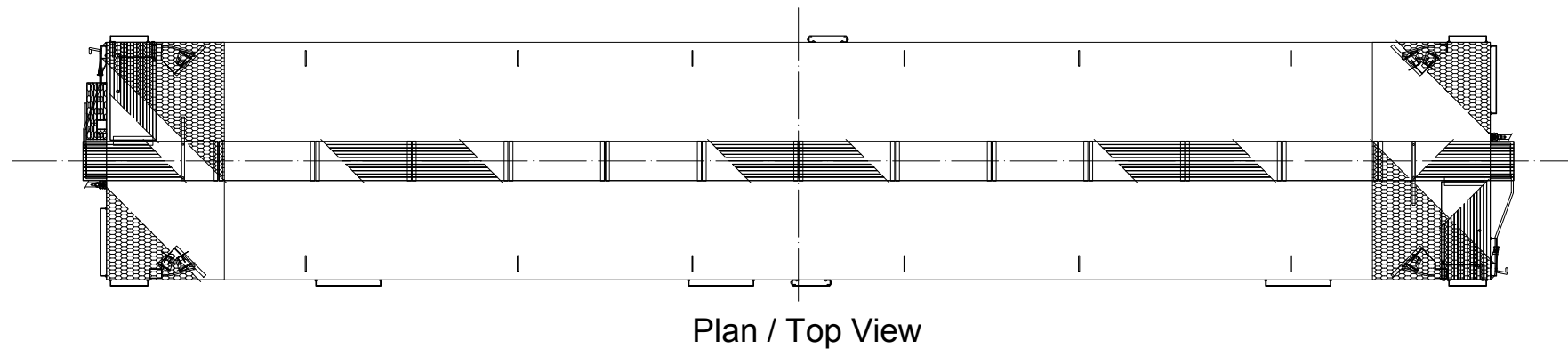

Plan / Top View

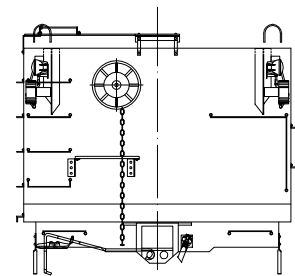

End View West
(leftside)

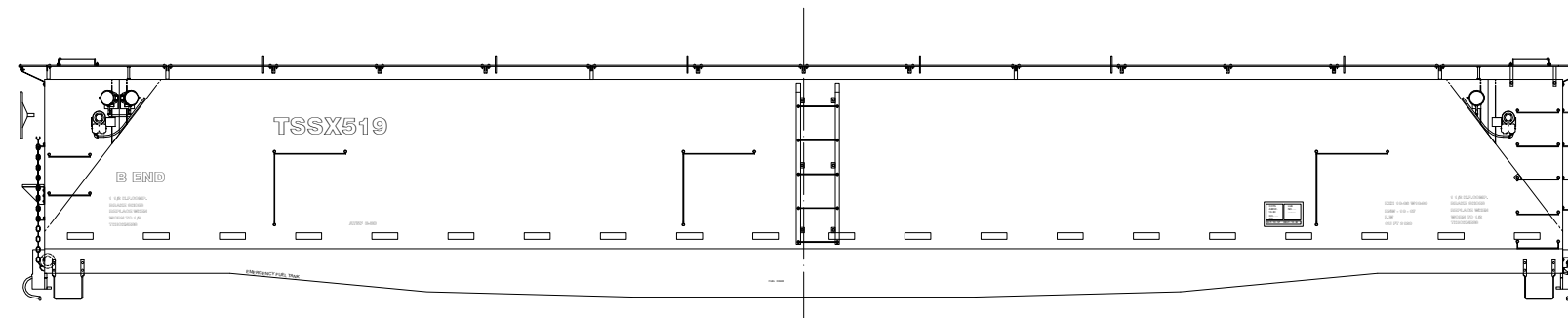

South Elevation View

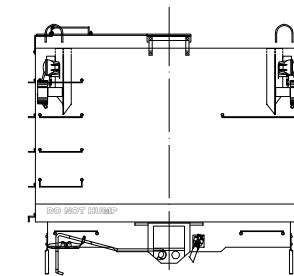

End View East
(rightside)

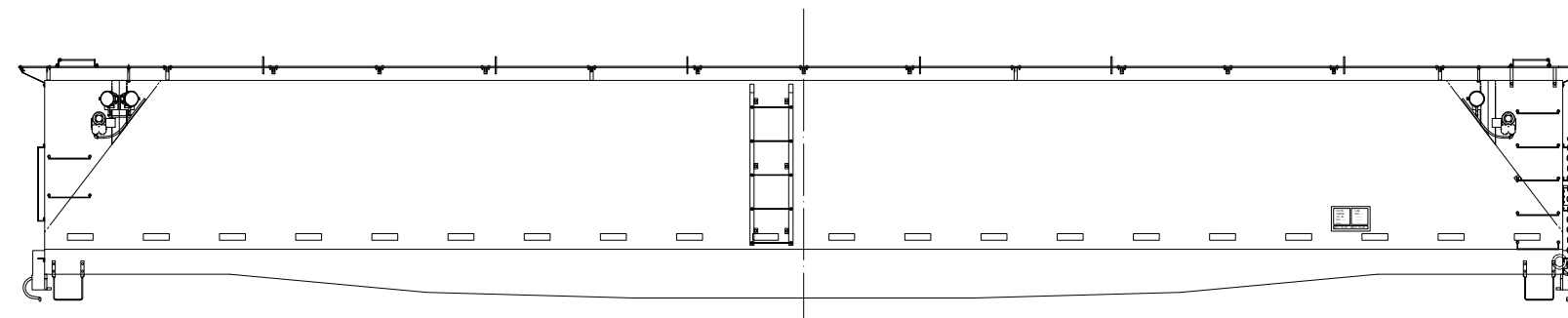

North Elevation View

Common Snap
POINT



106

Isolated Parts for discussion / verification / modeling options
White Train Buffer Car Unit / Plans & Elev Views
 for: **Amarillo Railroad Museum HO Layout**

SCALE: 0.5517 = 48 units
 1/87 HO Scale 3.5mm = 1 ft

F
 Print Date:
 10-25-2019

b carter designs
 Commercial Interiors
 Space Planning / Design
 P O Box 33781 Amarillo, TX 79120
 Mob 806-690-3410 Hm 806-352-8459
 bcarterdesigns@att.net